

SPEC SHEETS

Round Straight Steel Poles



Specifications, Options, and Accessories

General Structures' Round Straight Steel Poles are engineered to meet the rigorous demands of the natural environment. The information below can be used to determine the exact pole needed for a variety of lighting applications.

Please note that standards mounted on structures (parking garages, buildings, bridges, piers, etc.) require factory consultation.

POLE SHAFT SPECIFICATIONS

- The pole shaft is one-piece construction — fabricated from a weldable-grade carbon steel structural tubing with a uniform wall thickness. The pole shaft material conforms to ASTM A-500 Grade B with a minimum yield strength of 46,000 psi. It has a full-length longitudinal resistance weld and is uniformly round in cross section.

BASE PLATE COVER

- Anchor-based designs include a two-piece, removeable base cover. The square base cover has a round center to accommodate the pole shaft and is made of automotive-structural-grade ABS plastic with a UV inhibitor to mitigate color fading. It is rust proof and tamper resistant.

ANCHOR BOLTS

- Four (4) 1554 Grade 55 “L-bent” anchor bolts are supplied with each anchor-based design. The size of the bolts are determined by the pole type. Our 3/4” anchor bolts are fully galvanized. All other sizes are partially galvanized on the threaded side of the bolt only. Fully galvanized bolts are available upon request. Our anchor bolts are rated to 55,000psi.

DIRECT BURIAL

- For embedded designs, an optional alkali-resistant, coal-tar epoxy can be applied to the burial portion of embedded poles. Our direct-burial poles are supplied complete with a 2”x4” wiring slot located 18” below grade.

HAND HOLE

- All of our round steel poles include an oval-shaped handhole. Handholes are installed 14.00” above finished grade and they are sized to allow contractors to make required electrical connections without compromising the pole’s structural integrity. Each pole’s small parts kit includes a gasketed hand hole cover that limits access to the pole’s interior when installed. Each pole comes with a complete curved, galvanized-steel hand hole cover assembly to match the finish of the pole.

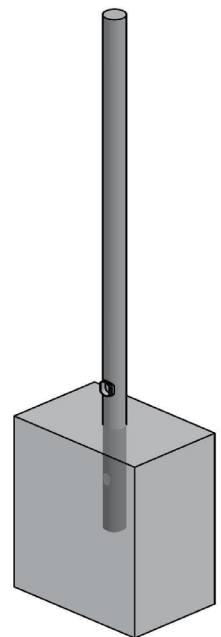
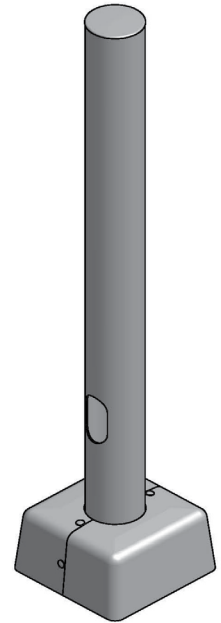

WIND LOADING DATA: AASHTO

2013 AASHTO LTS-6

PART #	Diameter (A)x Wall (B)x Height (C)	Plate	Bolt Circle (Range)	Max Luminaire Weight	Pole EPA Rating						
					80 MPH	90 MPH	100 MPH	110 MPH	120 MPH	130 MPH	140 MPH
CPS-4-3011-8	3" x 11 ga. x 8'	8" x 0.75" Thick	8.5" (8"-9")	200	14.1	10.9	8.6	6.9	5.6	4.6	3.8
CPS-4-3011-10	3" x 11 ga. x 10'	8" x 0.75" Thick	8.5" (8"-9")	200	10.6	8.1	6.3	4.9	3.9	3.1	2.5
CPS-4-3011-12	3" x 11 ga. x 12'	8" x 0.75" Thick	8.5" (8"-9")	200	8.1	6	4.6	3.5	2.6	2	1.5
CPS-4-3011-14	3" x 11 ga. x 14'	8" x 0.75" Thick	8.5" (8"-9")	200	6.2	4.5	3.3	2.3	1.7	1.1	0.7
CPS-4-4011-14	4" x 11 ga. x 14'	8" x 0.75" Thick	8.5" (8"-9")	200	13.9	10.5	8	6.1	4.8	4	3.3
CPS-4-4011-16	4" x 11 ga. x 16'	8" x 0.75" Thick	8.5" (8"-9")	200	11.3	8.3	6.2	4.6	3.5	2.8	2.3
CPS-4-4011-18	4" x 11 ga. x 18'	8" x 0.75" Thick	8.5" (8"-9")	200	9.1	6.5	4.6	3.1	2.3	1.7	1.3
CPS-4-4011-20	4" x 11 ga. x 20'	8" x 0.75" Thick	8.5" (8"-9")	200	7.1	4.8	3.2	2.1	1.2	0.7	0.4
CPS-4-5011-25	5" x 11 ga. x 25'	8" x 0.75" Thick	8.5" (8"-9")	200	8	5.1	3.3	2.1	1.5	1.1	0.8
CPS-4-5007-25	5" x 7 ga. x 25'	10" x 1.00" Thick	10" (9.5"-10.5")	200	14.5	10.4	7.5	5.6	4.5	3.6	2.9
CPS-4-5011-30	5" x 11 ga. x 30'	8" x 0.75" Thick	8.5" (8"-9")	200	3.9	1.8	0.3	N/A	N/A	N/A	N/A
CPS-4-5007-30	5" x 7 ga. x 30'	10" x 1.00" Thick	10" (9.5"-10.5")	200	9.2	5.9	3.7	2.3	1.6	1.1	0.7

For steel poles, we have the ability to modify the base plate to accommodate alternate bolt circles to fit existing anchor bolt patterns. Note that we can only increase the size to the standard bolt circle; we cannot accommodate decreased bolt circle sizes for our cataloged poles. Contact the factory with any questions. New anchor bolts should be set using factory-supplied anchor bolt templates.

Vibration dampeners are recommended for poles 25' and above.

Aashto Wind Map

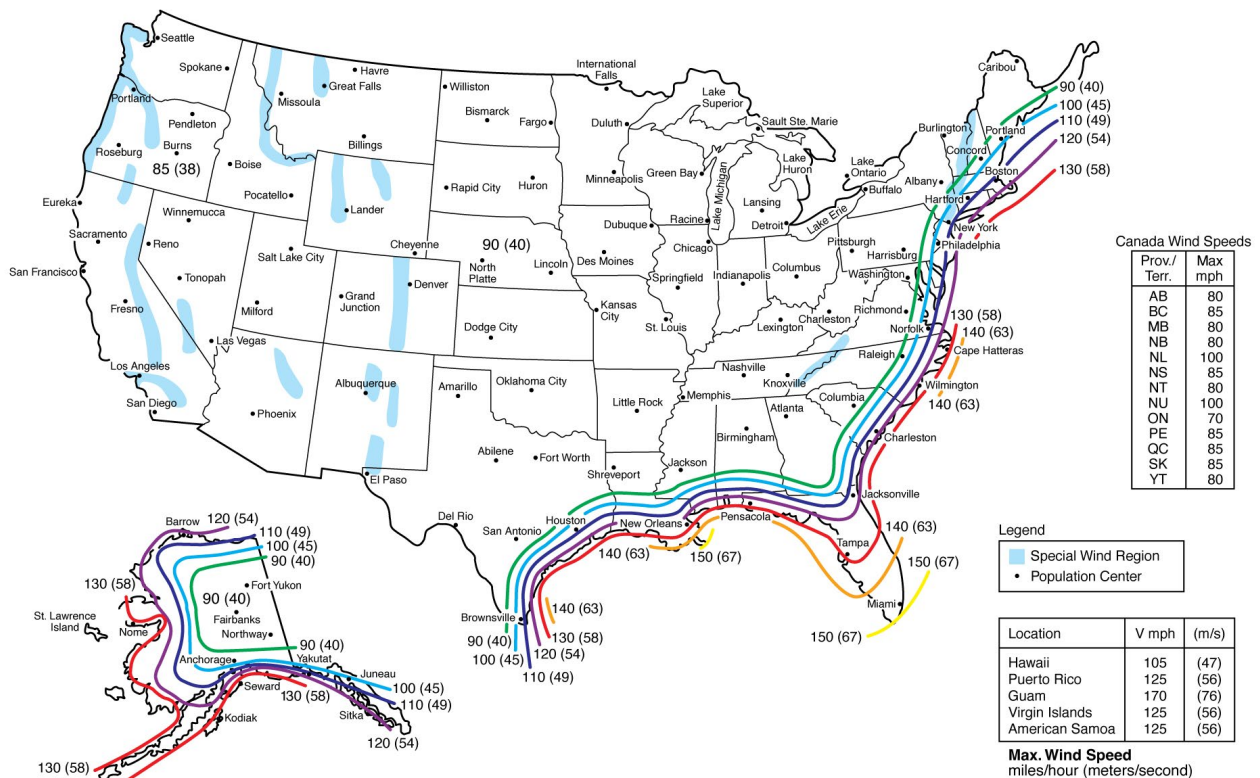

WIND LOADING DATA: FLORIDA BUILDING CODE

2023 FBC / ASCE-7 / 2017 AASHTO LTS-1

PART #	Diameter (A) x Wall (B) x Height (C)	Plate	Bolt Circle (Range)	Max Luminaire Weight	Pole EPA Rating						
					120 MPH	130 MPH	140 MPH	150 MPH	160 MPH	170 MPH	180 MPH
CPS-4-3011-8	3" x 11 ga. x 8'	8" x 0.75" Thick	8.5" (8"-9")	200	19.7	16.7	14.2	12.2	10.6	9.2	8.1
				500	18.1	15.2	13	11.1	9.6	8.4	7.3
CPS-4-3011-10	3" x 11 ga. x 10'	8" x 0.75" Thick	8.5" (8"-9")	200	15.3	12.8	10.8	9.2	7.9	6.8	5.9
				500	13.9	11.6	9.8	8.3	7.1	6.1	5.3
CPS-4-3011-12	3" x 11 ga. x 12'	8" x 0.75" Thick	8.5" (8"-9")	200	12.2	10.1	8.5	7.1	6	5.1	4.4
				500	11	9.1	7.6	6.4	5.4	4.5	3.9
CPS-4-3011-14	3" x 11 ga. x 14'	8" x 0.75" Thick	8.5" (8"-9")	200	9.9	8.1	6.7	5.5	4.6	3.8	3.2
				500	8.9	7.2	5.9	4.9	4	3.3	2.7
CPS-4-4011-14	4" x 11 ga. x 14'	8" x 0.75" Thick	8.5" (8"-9")	200	19.5	16.2	13.5	11.4	9.7	9.4	8.2
				500	18.4	15.4	12.8	10.7	9.1	8.9	7.8
CPS-4-4011-16	4" x 11 ga. x 16'	8" x 0.75" Thick	8.5" (8"-9")	200	16.1	13.2	10.9	9.1	7.6	7.7	6.7
				500	15.2	12.4	10.3	8.5	7.1	7.3	6.3
CPS-4-4011-18	4" x 11 ga. x 18'	8" x 0.75" Thick	8.5" (8"-9")	200	13.2	10.7	8.7	7.1	5.8	6.1	5.3
				500	12.4	10	8.1	6.6	5.4	5.8	5
CPS-4-4011-20	4" x 11 ga. x 20'	8" x 0.75" Thick	8.5" (8"-9")	200	10.8	8.6	6.9	5.5	4.4	5	4.2
				500	10.1	8.1	6.4	5.1	4	4.7	3.9
CPS-4-5011-25	5" x 11 ga. x 25'	8" x 0.75" Thick	8.5" (8"-9")	200	5.6	5.5	5	3.9	3	2.3	1.7
				500	9.7	8.4	7.9	6.5	5.3	4.4	3.6
CPS-4-5007-25	5" x 7 ga. x 25'	10" x 1.00" Thick	10" (9.5"-10.5")	200	20.1	17.9	15.7	13.2	11.2	9.5	8.1
				500	19.8	17.6	15.4	13	11	9.3	8
CPS-4-5011-30	5" x 11 ga. x 30'	8" x 0.75" Thick	8.5" (8"-9")	200	2.3	3.1	2.7	1.8	1.1	0.5	N/A
				500	1.9	2.8	2.5	1.6	0.9	0.3	N/A
CPS-4-5007-30	5" x 7 ga. x 30'	10" x 1.00" Thick	10" (9.5"-10.5")	200	13.9	13	11.3	9.3	7.7	6.3	5.2
				500	13.6	12.8	11.1	9.1	7.5	6.2	5.1

For steel poles, we have the ability to modify the base plate to accommodate alternate bolt circles to fit existing anchor bolt patterns. Note that we can only increase the size to the standard bolt circle; we cannot accommodate decreased bolt circle sizes for our cataloged poles. Contact the factory with any questions. New anchor bolts should be set using factory-supplied anchor bolt templates.

Vibration dampeners are recommended for poles 25' and above.

FBC Wind Map

Notes:

1. Values are nominal design 3-second gust wind speeds in miles per hour (m/s) at 33 ft (10 m) above ground for Exposure C category.
2. Linear interpolation between wind contours is permitted.
3. Islands and coastal areas outside the last contour shall use the last wind speed contour in the coastal area.
4. Mountainous terrain, gorges, ocean promontories, and special wind regions shall be examined for unusual wind conditions.
5. Wind speeds correspond to approximately a 7% probability of exceedance in 50 years (Annual Exceedance Probability = 0.00143, MRI = 700 years).
6. This map is accurate to the county. Local Governments establish specific wind speed/wind-borne debris lines using physical landmarks such as major roads, canals, rivers and shorelines.
7. Within 1 mile (1.61 km) of the mean high-water line where and Exposure D condition exists upwind at the waterline and the ultimate design wind speed, V_{ult} is 130 mph (58 m/s) or greater.
8. Location-specific wind speeds shall be permitted to be determined using the ASCE Wind Design Geodatabase. The ASCE Wind Design Geodatabase can be accessed at the ASCE 7 Hazard Tool (<https://asce7hazardtool.online>) or equivalent.

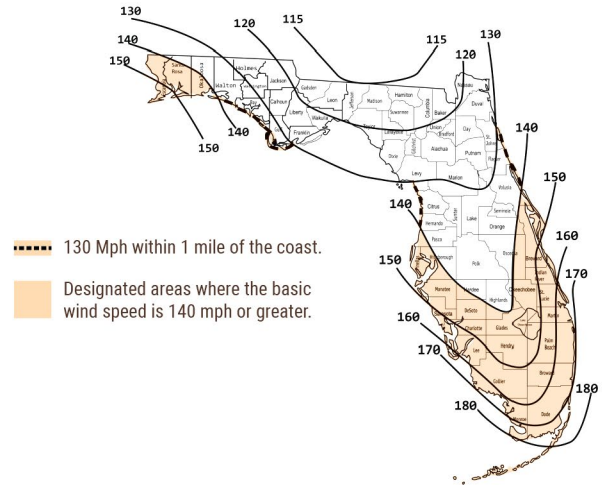

POLE DETAILS

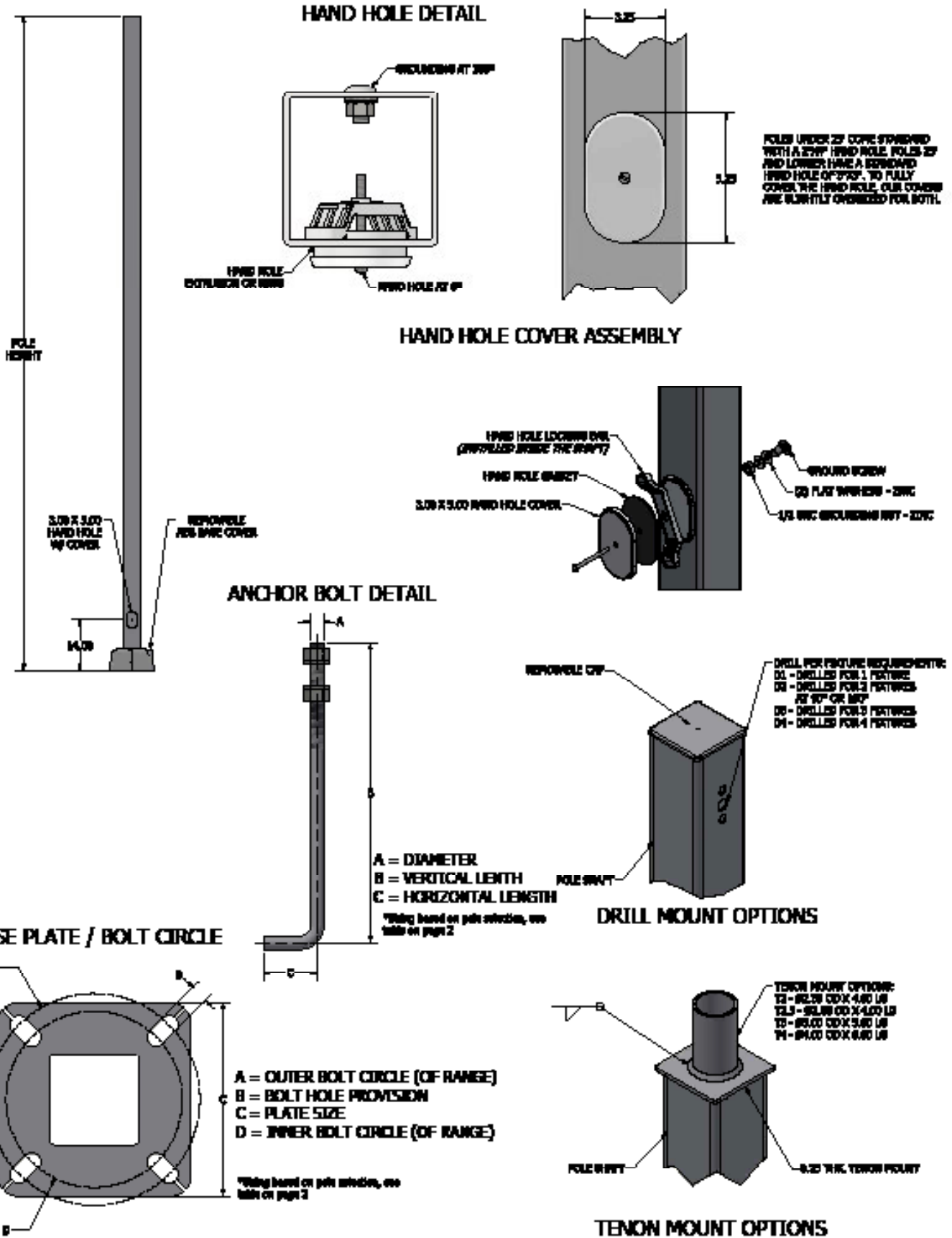

BUILD YOUR PART NUMBER

The information below allows you to pull together the exact part number for the Square Straight Steel Pole required for your application. Details about the various options and accessories available can be found on the following pages. **Please note that each option and accessory must denote a mounting orientation (hand hole is at 0°) and height from base the of the pole.**

Catalog Number (found in wind load tables)				Mounting Type	Fixture Mounting Arrangement	Finish	Options			Accessories		
Design	Shaft Size	Wall Thickness	Mounting Height				Design	Orientation	Height From Base	Design	Orientation	Height From Base

Mounting Type Options

AB = Anchor Base

EMB = Embedded (Direct Burial)

FIXTURE MOUNTING ARRANGEMENT OPTIONS

Drill Mount Options

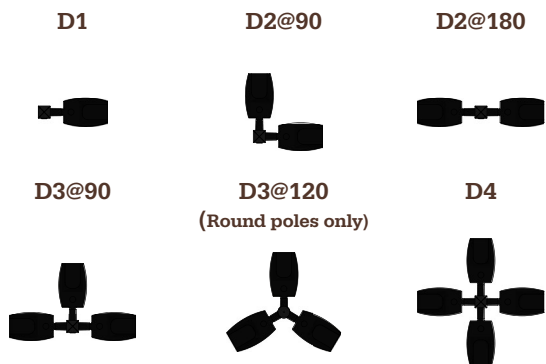

Tenon Mount Options

Design	Dia. (A)	Length (B)
T2	2.38"	4.00"
T2.5	2.88"	4.00"
T3	3.00"	5.00"
T4	4.00"	6.00"

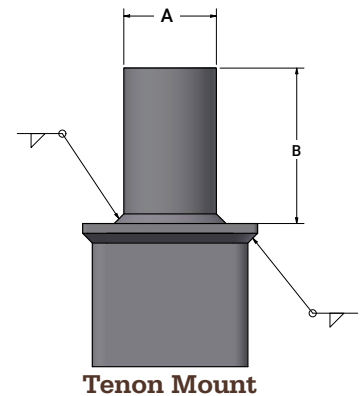

FINISH OPTIONS

Standard Finishes

- WH = White
- TWH = Textured White
- DB = Dark Bronze
- HB = Harvest Bronze
- TMB = Textured Medium Bronze
- NB = New Bronze
- SL = Silver
- MGY = Medium Gray
- GR = Gray
- TGR = Textured Gray
- MA = Matte Aluminum

Premium Finishes

- GM = Graphite Metallic
- DP = Dark Platinum
- MG = Moss Green

AVAILABLE OPTIONS

- CSBC = Custom Steel Base Cover
- MODBASE = Modified Steel Base Plate
- VD = Vibration Dampener
- GFI = Ground Fault Circuit Interrupter
- FESTOON = Switch or Receptacle Mounting Provision
- CMB = Camera Mounting
- Bracket
- CMP = Camera Mounting Plate
- WB = Welded Bracket
- WC = Welded Coupling
- WN = Welded Nipple
- PE = Pad Eye
- SCP = Shielded Circuit Provision
- XHH = Extra Hand Hole
- FGAB = Fully Galvanized Anchor Bolts
- L/AB = Anchor Bolt Deduct
- UL = UL Listed
- CSA = CSA Listed
- BUY AMERICA = Buy America Act (BAA) Requirement for US-Sourced Steel (must be requested at time of order)

AVAILABLE ACCESSORIES

- BA = Banner Arm
- FH = Flag Holder
- FPH = Flower Pot Holder
- PTTA = Pole Top Tenon Adapter
- BAC = Breakaway Couplings
- TTAP = Two-Tier Adapter Plate
- SAC = Spun Aluminum Collar

AVAILABLE OPTIONS DETAIL

Custom Steel Base Cover

Design	Description
CSBC	Custom Steel Base Cover

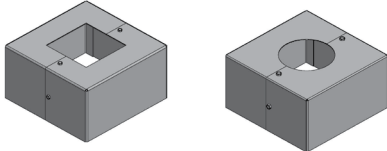

Vibration Dampener*

Design	Description
VD	Recommended for use with all poles 25' and higher

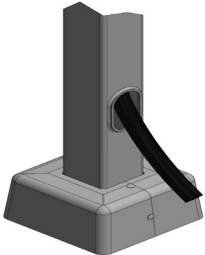

*All vibration dampeners are plus freight if purchased and shipped separately.

Festoon - Switch or Receptacle Mounting Provision

Design	Description
FESTOON	Mounting provision for customer-supplied switch or standard receptacle.

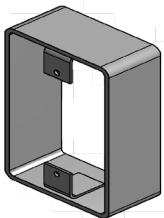

*Requires a mounting location of a minimum of 10" above hand hole to not affect the structural integrity of the pole.

Welded Bracket

Design	Description
WB	2-3/8" OD Bent Slip-fit Pipe Bracket Welded on Pole

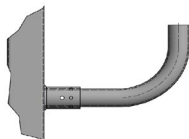

Modified Steel Base Plate*

Design	Description
MODBASE	Accommodate existing bolt patterns or other required specifications on steel poles. Plates can only be made to increase the standard bolt circle of a pole, smaller bolt circles cannot be accommodated. Bolt circle size must be provided to release an order.

*Includes custom steel base cover to fit

Ground Fault Circuit Interrupter*

Design	Description
GFI	Weatherproof 15-20 amp. 125V A/C Recessed Ground Fault Circuit Interrupter with In Use Cover

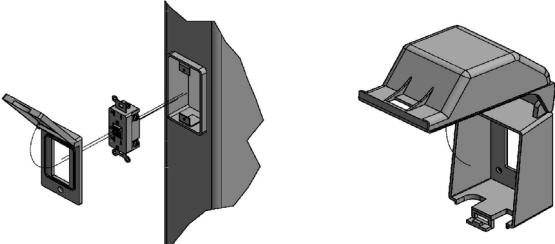

*Requires a mounting location of a minimum of 10" above hand hole to not affect the structural integrity of the pole.

Mounting Bracket

Design	Description
CMB	Mounting Bracket
CMP	Mounting Plate

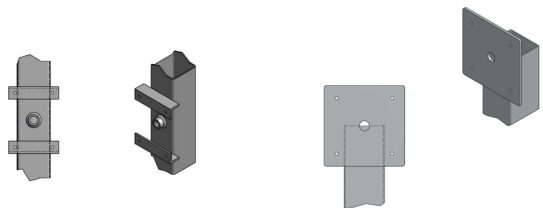

Welded Coupling*

Design	Description
WC	Threaded Pipe Coupling with Wire Hole Welded to Pole



*See cutsheet on our website for available coupling sizes.

Available Options Detail (continued)

Welded Nipple

Design	Description
WN	Threaded Pipe Nipple with Wire Hole Welded to Pole



Pad Eye

Design	Description
PE	Welded Padeye Provision Available in Aluminum or Steel to Match Pole

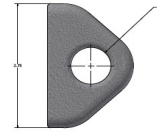

Shielded Circuit Provision

Design	Description
SCP	Shielded Circuit Mounting Provision

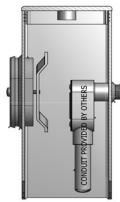

Extra Hand Hole*

Design	Description
XHH	Extra Hand Hole Provision Located as Specified on Order

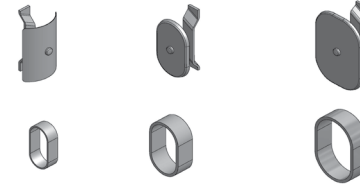

*Includes hand hole cover assembly.

Fully Galvanized Anchor Bolts*

Catalog Number	Description (in.)
FGAB	3/4" x 20"
	3/4" x 28"
	1" o.d.
	1.5" o.d.



*3/4" x 20" standard bolt is fully galvanized, all other anchor bolts are partially galvanized on the threaded end only.

Anchor Bolt Deduct — Used When Customer Does Not Want Anchor Bolts Shipped

Catalog Number	Description
L/AB	Deduct amount for all 3/4" anchor bolts (see pole type matrices for anchor bolt size)
	Deduct amount for all 1" anchor bolts (see pole type matrices for anchor bolt size)

UL or CSA Listing

Catalog Number	Description
UL	Poles can be ordered to meet UL requirements. "UL" must appear in the part number. UL Listed poles include a metal hand hole cover and UL label.
CSA	Poles can be ordered to meet CSA requirements. "CSA" must appear in the part number. CSA approved poles include required grounding provision and CSA label.



LUMINAIRE POLE WITH RESPECT TO ELECTRICAL HAZARDS ONLY <E473617>



CLASS - 3426 03 - LUMINAIRES - LUMINAIRE POLES

CATALOG NUMBER

YEAR OF MANUFACTURE

SUITABLE FOR WET LOCATIONS.

AVAILABLE ACCESSORIES DETAIL

Banner Arm — Includes Top And Bottom Arm

Catalog Number	Description
BA	Banner Arm 25" or 31"

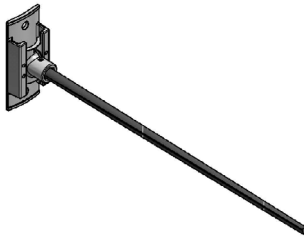

Flower Pot Holder

Catalog Number	Description
FPH	Flower Pot Holder



Break Away Couplings*

Catalog Number	To Fit Anchor Bolt Size (in.)
BAC-.75-SET	0.75 O.D.
BAC-1.0-SET	1.00 O.D.

*Break away couplings provided with square skirt cover.

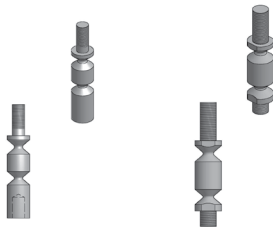

Spun Aluminum Collar

Catalog Number	Description	Size (dla.)
SAC-XX'	Made from aluminum alloy 1100, these spun collars are 1/3" thick and have deburred, even edges. Available in natural-aluminum or powder-coated finishes.	4", 4.5", 5", 6", 7", 8", 10"
SAC-12"		12"

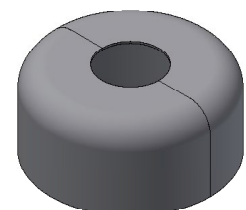

Flag Holder

Catalog Number	Description
FH	Flag Holder

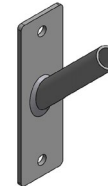

PTTA — Square Pole Top Tenon Adapters

Catalog Number	Drill Mount Options	Height (in.)	Pole Size (in. sq.)
PTTA-4SQ-DXX	D1,D2,D3,D4	13	4
PTTA-5SQ-DXX	D1,D2,D3,D4	13	5
PTTA-6SQ-DXX	D1,D2,D3,D4	13	6



Two-Tier Adapter Plate*

Catalog Number	Min Bolt Circle (in.)	Max Bolt Circle (in.)	Included Base Cover
TTAP	-----	12	YES
TTAP-16	12	16	YES

*Includes connecting hardware and Square Steel Base Cover

